

IMP-IF1

Impulse Interface Adapter



The IMP-IF1 interface adapter is suitable for interfacing MTE reference standards with meters having retransmitting contacts, open-collector transistor outputs or true S0-outputs to allow full testing of meters with these types of outputs interfaces.

IMP-IF 1 functions

- Active input for testing S0 outputs, according to the DIN 43864 standard

- Input for testing passive pulse outputs such relay contacts prone to bounce or open collector transistor outputs
- Input for testing active outputs

The required function may be selected using the slide switch. For the output connector, a suitable 1:1 interface cable with a 6/4-adapter should be used. (see table below) The two cables with 1.5 mm plugs are removable so that damaged cables may be replaced.

Block diagram

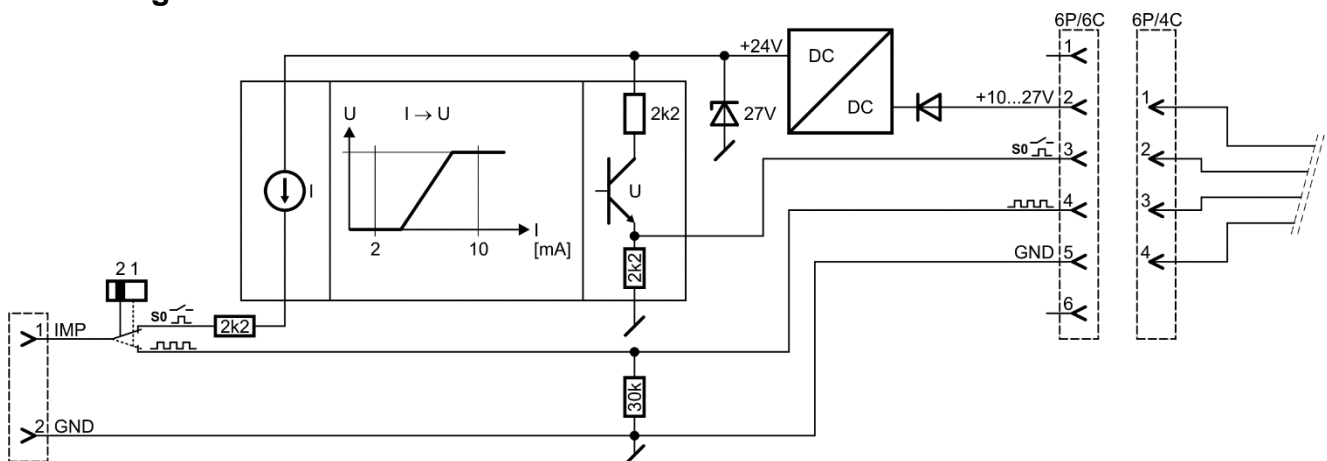

Technical data

Supply: +10 ... +27 V / I_{max} < 60 mA / P_{max} < 0.6 W

S0  Input:

Suitable for slow inputs, S0-inputs, passive free contacts or open-collector outputs

Output level: U (IMP-GND) = +24 V (independent of the supply voltage)

Switching time: according to the S0 standard

f_{max}: 50 Hz

Pulse current | S0  pulse output

I(IMP) ≤ 2 mA | LOW

I(IMP) ≥ 10 mA | HIGH

LOW / HIGH range: typically 3 ... 5 mA







 Input:

Suitable for fast, active pulses. This input is directly connected to the  output.

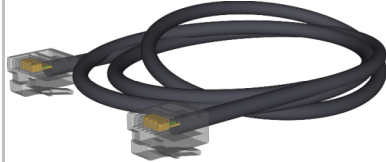
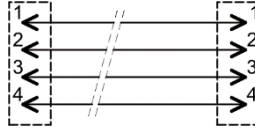
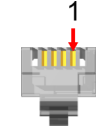
Input resistance: 30 kΩ (GND-IMP) (assumes no parallel burden is connected at the output)

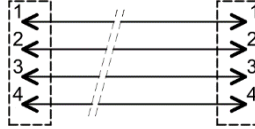
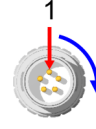
f_{max}: 200 kHz

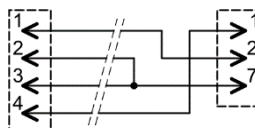
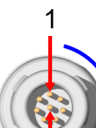
IMP-IF1 interface cables

For use with:		Connector type (view on plug)	Connection details
<ul style="list-style-type: none"> • SMM 397 • SMM 400 		 Length: 1 m	 Pin 1 ⇨ Supply Pin 2 ⇨ Slow input Pin 3 ⇨ Fast input Pin 4 ⇨ GND
<ul style="list-style-type: none"> • K2006 • PRS 400.3 • CALPORT 300 • PWS 3.3 • PWS 2.3 PLUS • CheckMeter 2.1 • CheckMeter 2.3 • PTS 2.1 C • PTS 2.3 C • PTS 3.1 C • PTS 3.3 C 		 Length: 2 m	 Pin 1 ⇨ Supply Pin 2 ⇨ Slow input Pin 3 ⇨ Fast input Pin 4 ⇨ GND Pin 5 ⇨ not used
<ul style="list-style-type: none"> • CheckSystem 2.1 • CheckSystem 2.3 		 Length: 2 m	 Pin 1 ⇨ GND Pin 2 ⇨ Supply Pin 7 ⇨ Impulse
<ul style="list-style-type: none"> • Testing cable 		2 mm plugs / Length: 150 mm Multi Contact AG	Red ⇨ Impulse Black ⇨ GND